

Plug-in timers 8 A

88
SERIES



Drying kilns



Industrial furnaces and ovens



Industrial washing machines



Hoists and cranes



Wood-processing machines



Medical and dentistry



**Multi-voltage and multi-function timer range
Front panel or socket mount**

- 8 and 11 pin plug-in versions available
- Time scales from 0.05 s to 100 h
- "1 delayed contact + 1 instantaneous contact" version available (type 88.12)
- Front panel mounting fixing included
- 90 series sockets

88.02



- Multi-function
- 11 pin
- Plug-in for use with 90 series sockets

88.12



- Multi-function
- 8 pin, 2 timed contacts or 1 timed + 1 instantaneous contact
- Plug-in for use with 90 series sockets

AI: On-delay

DI: Interval

GI: Pulse delayed

SP: Symmetrical flasher (starting pulse off) without control signal



BE: Off-delay with control signal

CEa: On- and off-delay with control signal

DE: Interval with control signal on

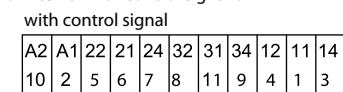

P = Pause
S = Start
R = Reset

AI a: On-delay (2 timed contacts)

AI b: On-delay (1 timed + 1 instantaneous contact)

DI a: Interval (2 timed contacts)

DI b: Interval (1 timed + 1 instantaneous contact)

GI: Pulse delayed

SW: Symmetrical flasher (starting pulse on)

without control signal

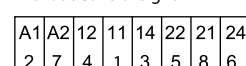

For outline drawing see page 5

Contact specification

Contact configuration		2 CO (DPDT)	2 CO (DPDT)
Rated current/Maximum peak current	A	8/15	8/15
Rated voltage/ Maximum switching voltage	V AC	250/400	250/400
Rated load AC1	VA	2000	2000
Rated load AC15 (230 V AC)	VA	400	400
Single phase motor rating (230 V AC)	kW	0.3	0.3
Breaking capacity DC1: 30/110/220 V	A	8/0.3/0.12	8/0.3/0.12
Minimum switching load	mW (V/mA)	300 (5/5)	300 (5/5)
Standard contact material		AgNi	AgNi

Supply specification

Nominal voltage (U _n)	V AC (50/60 Hz)	24...230	24...230
	V DC	24...230	24...230
Rated power AC/DC	VA (50 Hz)/W	2.5 (230 V)/1 (24 V)	2.5 (230 V)/1.5 (24 V)
Operating range	V AC	20.4...264.5	20.4...264.5
	V DC	20.4...264.5	20.4...264.5

Technical data

Specified time range		(0.05 s...5 h) - (0.05 s...10 h) - (0.05 s...50 h) - (0.05 s...100 h)	
Repeatability	%	± 1	± 1
Recovery time	ms	300	200
Minimum control impulse	ms	50	—
Setting accuracy-full range	%	± 3	± 3
Electrical life at rated load AC1	cycles	100 · 10 ³	100 · 10 ³
Ambient temperature range	°C	-10...+55	-10...+55
Protection category		IP 40	IP 40

Approvals (according to type)



- Multi-voltage and mono-function timer range**
Front panel or socket mount
- Asymmetrical flasher The ON and OFF time are independently adjustable
 - 8 pin plug-in
 - Time scales from 0.05 s to 300 h
 - 2 contacts
 - Front panel mounting fixing included
 - 90 series sockets

88.92 - 0000



- Mono-function
- 8 pin, 2 timed contacts
- Plug-in for use with 90 series sockets

PI: Asymmetrical flasher (starting pulse OFF)

without control signal

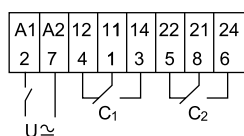

88.92 - 0001



- Mono-function
- 8 pin, 2 timed contacts
- Plug-in for use with 90 series sockets

LI: Asymmetrical flasher (starting pulse ON)

without control signal

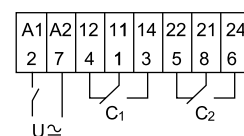

For outline drawing see page 5

Contact specification

Contact configuration		2 CO (DPDT)	2 CO (DPDT)
Rated current/Maximum peak current	A	8/15	8/15
Rated voltage/ Maximum switching voltage	V AC	250/400	250/400
Rated load AC1	VA	2000	2000
Rated load AC15 (230 V AC)	VA	400	400
Single phase motor rating (230 V AC)	kW	0.3	0.3
Breaking capacity DC1: 30/110/220 V	A	8/0.3/0.12	8/0.3/0.12
Minimum switching load	mW (V/mA)	300 (5/5)	300 (5/5)
Standard contact material		AgNi	AgNi

Supply specification

Nominal voltage (U _N)	V AC (50/60 Hz)	12...240	12...240
	V DC	12...240	12...240
Rated power AC/DC	VA (50 Hz)/W	2.5 (230 V)/1.5 (24 V)	2.5 (230 V)/1.5 (24 V)
Operating range	V AC	10.8...264.5	10.8...264.5
	V DC	10.8...264.5	10.8...264.5

Technical data

Specified time range		See "Time Scale" page 6	See "Time Scale" page 6
Repeatability	%	± 1	± 1
Recovery time	ms	200	200
Minimum control impulse	ms	—	—
Setting accuracy-full range	%	± 1	± 1
Electrical life at rated load AC1	cycles	100 · 10 ³	100 · 10 ³
Ambient temperature range	°C	-10...+55	-10...+55
Protection category		IP 40	IP 40

Approvals (according to type)



Ordering information

Example: 88 series multi-function timer, 2 CO (DPDT) 8 A contacts, (24...230)V AC (50/60 Hz) and (24...230)V DC supply.



Series

Type

- 0 = Functions AI, DI, GI, SP, BE, CEa, DE, 11 pin
- 1 = Functions AI a, AI b, DI a, DI b, GI, SW, 8 pin
- 9 = Functions LI, PI, 8 pin

No. of poles

2 = 2 pole

Supply version

0 = AC (50/60 Hz)/DC

Special versions

- 0 = Functions PI (starting pulse OFF) for 88.92
- 1 = Functions LI (starting pulse ON) for 88.92
- 2 = Standard

Supply voltage

- 230 = (24...230)V AC/DC for 88.02, 88.12
- 240 = (12...240)V AC/DC for 88.92

Codes

- 88.02.0.230.0002
- 88.12.0.230.0002
- 88.92.0.240.0000
- 88.92.0.240.0001

Technical data

EMC specifications

Type of test		Reference standard	88.02/88.12	88.92
Electrostatic discharge	contact discharge	EN 61000-4-2	4 kV	4 kV
	air discharge	EN 61000-4-2	8 kV	6 kV
Radio-frequency electromagnetic field (80 ÷ 1000 MHz)		EN 61000-4-3	10 V/m	10 V/m
Fast transients (burst) (5-50 ns, 5 kHz) on Supply terminals		EN 61000-4-4	2 kV	—
Surges (1.2/50 µs) on Supply terminals	common mode	EN 61000-4-5	2 kV	—
	differential mode	EN 61000-4-5	1 kV	—
Radio-frequency common mode (0.15 ÷ 80 MHz) on Supply terminals		EN 61000-4-6	3 V	—

Other data

Power lost to the environment	without contact current W	3.4
	with rated current W	4.7

Outline drawings

Types 88.02/12

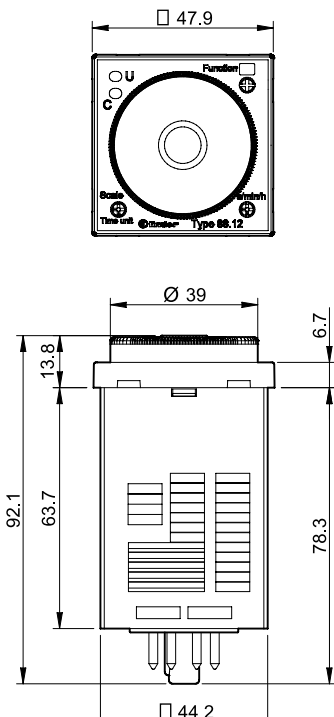

Type 88.92

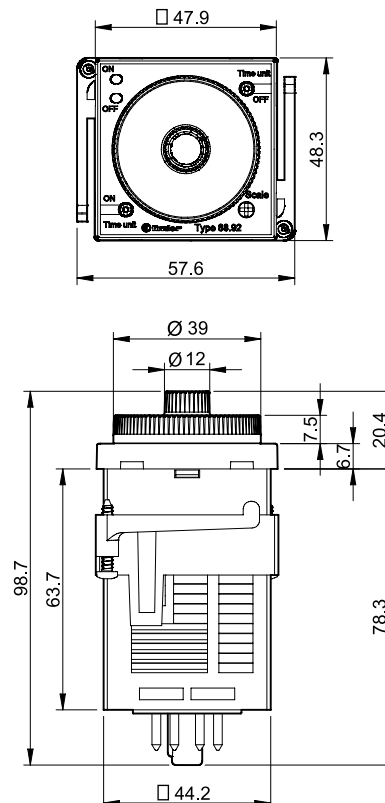

Selection of: function, time scale and units

	88.02	88.12	88.92 - 0000	88.92 - 0001
Function	Al, DI, GI, SP, BE, CEa, DE	Al a, Al b, DI a, DI b, GI, SW	PI	LI
Time scale	0.5, 1, 5, 10		1.2, 3, 12, 30	
Unit of time	s (second), min (minute), h (hour), 10 h (10 hours)		s (second), 10 s (second x 10), min (minute), 10 min (minute x 10), h (hour), 10 h (hour x 10)	

Time scales

Full scale value for types 88.02, 88.12

D	H	s	min	h	10 h
0.5		0.5 second	0.5 minute	0.5 hour	5 hour
1		1 second	1 minute	1 hour	10 hour
5		5 second	5 minute	5 hour	50 hour
10		10 second	10 minute	10 hour	100 hour

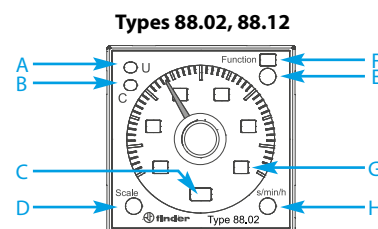

Full scale value for type 88.92

H	D-E	s	10 s	min	10 min	h	10 h
1.2		1.2 second	12 second	1.2 minute	12 minute	1.2 hour	12 hour
3		3 second	30 second	3 minute	30 minute	3 hour	30 hour
12		12 second	120 second	12 minute	120 minute	12 hour	120 hour
30		30 second	300 second	30 minute	300 minute	30 hour	300 hour

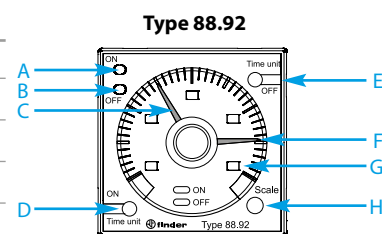

NOTE: time scales and functions must be set before energising the timer.

LED/visual indication

Types 88.02, 88.12

A	Yellow LED: power ON (U)
B	Red LED: timing in progress (C)
C	Unit of time selected
D	Time scale selector
E	Function selector
F	Function selected
G	Time scale selected
H	Unit of time selector

Type 88.92

A	Red LED: pulse ON (T1)
B	Green LED: pulse OFF (T2)
C	Red timing regulator: T1 time setting
D	Unit of time selector: T1 (ON)
E	Unit of time selector: T2 (OFF)
F	Green timing regulator: T2 time setting
G	Time scale selected
H	Time scale selector

Functions for types 88.02, 88.12

	LED (yellow)	LED (red)	Supply voltage	NO output contact	Contact	
					Open	Closed
U = Supply Voltage	_____	_____	OFF	Open	x1 - x4	x1 - x2
S = Signal switch	_____	_____	ON	Open	x1 - x4 x1 - x2	x1 - x2 x1 - x4
P = Pause	_____	_____	ON	Open (timing in progress)	x1 - x4	x1 - x2
R = Reset	_____	_____	ON	Closed	x1 - x2	x1 - x4

Wiring diagram

Type 88.02

without control signal

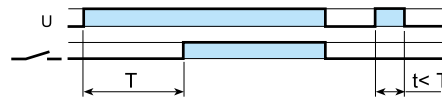
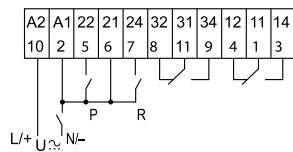

(AI) On-delay.

Apply power to timer. Output contacts transfer after preset time has elapsed. Reset occurs when power is removed.

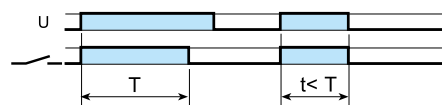

(DI) Interval.

Apply power to timer. Output contacts transfer immediately. After the preset time has elapsed, contacts reset.

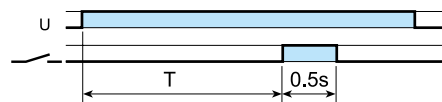

(GI) Pulse delayed.

Apply power to timer. Output contacts transfer after preset time has elapsed. Reset occurs after a fixed time of 0.5 s.

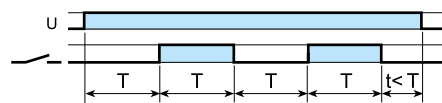

(SP) Symmetrical flasher (starting pulse off).

Apply power to timer. First transfer of contact occurs after preset time has elapsed. The timer now cycles between OFF and ON as long as power is applied. The ratio is 1:1 (time on = time off).

with control signal

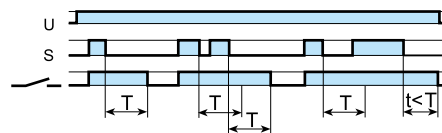
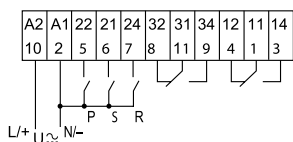

(BE) Off-delay with control signal.

Power is permanently applied to the timer. The output contacts transfer immediately on closure of the Signal Switch (S). Opening the Signal Switch initiates the preset delay, after which time the output contacts reset.

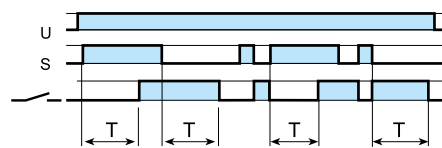

(CEa) On- and off-delay with control signal.

Power is permanently applied to the timer. Closing the Signal Switch (S) initiates the preset delay, after which time the output contacts transfer. Opening the Signal switch initiates the same preset delay, after which time the output contacts reset.

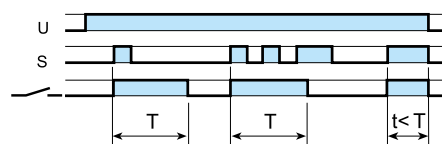

(DE) Interval with control signal on.

Power is permanently applied to the timer. On momentary or maintained closure of Signal Switch (S), the output contacts transfer, and remain so for the duration of the preset delay, after which they reset.

RESET (R)

A momentary closure of the reset switch (2-7) will reset the timer. Longer term closure of the reset switch will hold the timer in the reset state. This is applicable for all functions.

PAUSE (P)

Closure of the pause switch (2-5) will immediately halt the timing process, but the elapsed time will be retained, and the current state of the output contacts will be maintained.

On opening of the pause switch, timing resumes from the retained value. This is applicable for all functions.

Functions for type 88.12

Wiring diagram

Type 88.12

without control signal

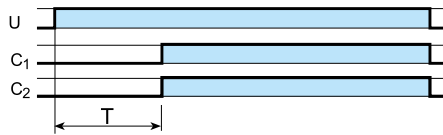
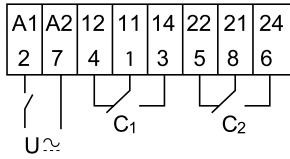

(AI a) On-delay (2 timed contacts).

Apply power to timer.
Contacts (C₁ and C₂) transfer after preset time has elapsed.
Reset occurs when power is removed.

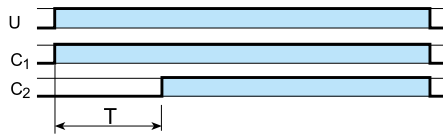

(AI b) On-delay

(1 timed contact + 1 instantaneous contact).

Apply power to timer. Output contact (C₁) transfers immediately.
Contact (C₂) transfers after the preset time has elapsed.
Reset occurs when power is removed.

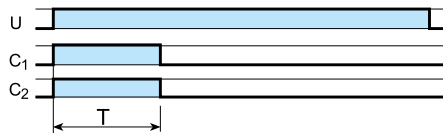

(DI a) Interval (2 timed contacts).

Apply power to timer.
Output contacts (C₁ and C₂) transfer immediately.
After preset time has elapsed, the contacts reset.

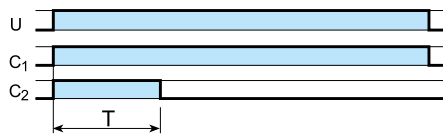

(DI b) Interval (1 timed contact + 1 instantaneous contact).

Apply power to timer. Output contacts (C₁ and C₂) transfer immediately. After preset time has elapsed, the contact (C₂) resets.
Contact (C₁) resets when power is removed.

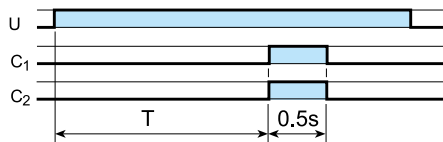

(GI) Pulse delayed.

Apply power to timer. Output contacts transfer after preset time has elapsed. Reset occurs after a fixed time of 0.5 s.

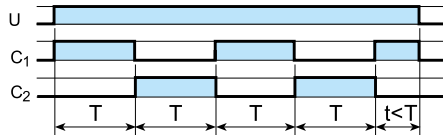

(SW) Symmetrical flasher (starting pulse on).

Apply power to timer. Output contacts transfer immediately and cycle between ON and OFF for as long as power is applied.
The ratio is 1:1 (time on = time off).

H

Functions for type 88.92

U = Supply Voltage

	LED ON (red)	LED OFF (green)	Supply voltage	Contact	
				Open	Closed
—	—	—	OFF	11 - 14 21 - 24	11 - 12 21 - 22
█	█	—	ON	11 - 12 21 - 22	11 - 14 21 - 24
—	—	█	ON	11 - 14 21 - 24	11 - 12 21 - 22

Wiring diagram

Type 88.92

without control signal

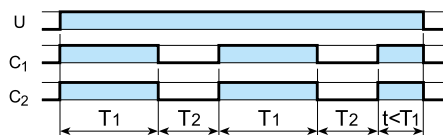
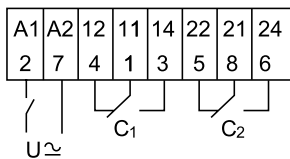

(LI) Asymmetrical flasher (starting pulse ON).

Apply power to timer. Output contacts transfer immediately and cycle between ON and OFF for as long as power is applied. The ON and OFF times are independently adjustable.

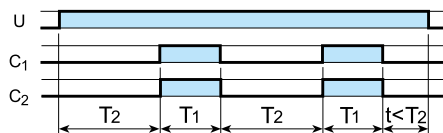

(PI) Asymmetrical flasher (starting pulse OFF).

Apply power to timer. Output contacts transfer after time T₂ has elapsed and cycle between OFF and ON for as long as power is applied. The ON and OFF times are independently adjustable.



90.21

Approvals
(according to type):



Screw terminal (Box clamp) socket panel or 35 mm rail (EN 60715) mount	90.20 Blue	90.20.0 Black	90.21 Blue	90.21.0 Black
For timer type	88.12, 88.92		88.02	
Technical data				
Rated values	10 A - 250 V			
Dielectric strength	2 kV AC			
Protection category	IP 20			
Ambient temperature	°C -40...+70			
⊕ Screw torque	Nm 0.5			
Wire strip length	mm 10			
Max. wire size for 90.20 and 90.21 sockets	solid wire		stranded wire	
	mm ² 1 x 6 / 2 x 2.5		1 x 6 / 2 x 2.5	
	AWG 1 x 10 / 2 x 14		1 x 10 / 2 x 14	

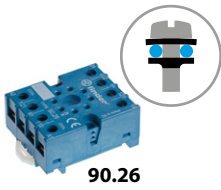
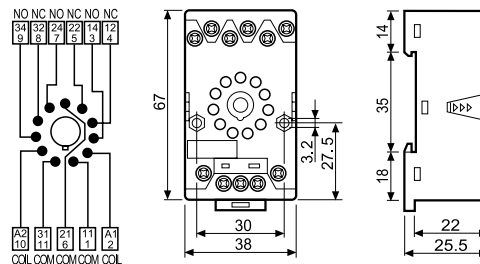
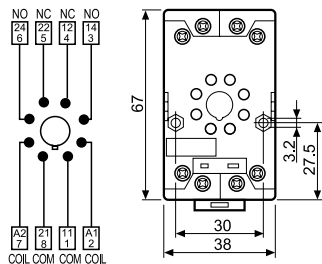

90.26

Approvals
(according to type):



Screw terminal (Box clamp) socket panel or 35 mm rail (EN 60715) mount	90.26 Blue	90.26.0 Black	90.27 Blue	90.27.0 Black
For timer type	88.12, 88.92		88.02	
Technical data				
Rated values	10 A - 250 V			
Dielectric strength	2 kV AC			
Protection category	IP 20			
Ambient temperature	°C -40...+70			
⊕ Screw torque	Nm 0.8			
Wire strip length	mm 10			
Max. wire size for 90.26 and 90.27 sockets	solid wire		stranded wire	
	mm ² 1 x 4 / 2 x 2.5		1 x 4 / 2 x 2.5	
	AWG 1 x 12 / 2 x 14		1 x 12 / 2 x 14	

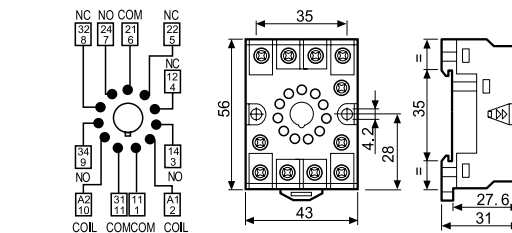
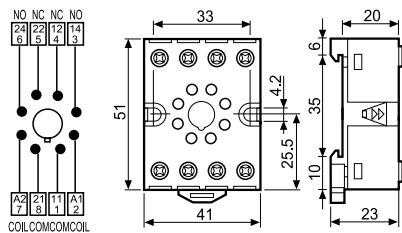

90.13.4

Approvals
(according to type):



Sockets 8-11 pin backwired with solder terminals	90.12.4 (black)	90.13.4 (black)
For timer type	88.12, 88.92	
Technical data		
Rated values	10 A - 250 V	
Dielectric strength	2 kV AC	
Ambient temperature	°C -40...+70	

