

SCR Power Controller Delivers Up To 80 Amperes in a Compact Package

The Watlow® DIN-A-MITE® Style C silicon controlled rectifier (SCR) power controller provides you with a low cost, compact and versatile solid state option for controlling electric heat. You also get all the quality you expect from a Watlow designed and manufactured product. DIN-rail and standard panel mounting plus a cabinet thru-wall mount version is available.

Basic features include single-phase, three-phase/two leg, and three-phase/three leg, 24-600V~(ac) operation. Current switching capabilities range from 30 to 80A depending on the model ordered.

Variable time base, linear voltage and current process control or $V \approx (ac/dc)$ input contactor versions are available. Also single-phase, phase angle firing and current limiting are available. All configurations are model number dependent and factory selectable. This power controller also includes 200KA short circuit current rating (SCCR) tested up to 480V~(ac) to prevent arch flash with required fusing.

The DIN-A-MITE power controller is made in the United States.

For Sales or Service:

Thermal Devices, Inc.
Mount Airy, Maryland USA
www.thermaldevices.com
sales@thermaldevices.com
Ph: 800-282-9100
Fx: 800-457-1634

Watlow® and DIN-A-MITE® are registered trademarks of Watlow Electric Manufacturing Company.

UL® and C-UL® are registered trademarks of the Underwriter's Laboratories, Inc.



Features and Benefits

200KA short circuit current rating (SCCR)

- Prevents arc flash

DIN-rail and standard panel mount thru-wall mounting

- Provides versatility, quickness and low-cost installation

Compact size

- Reduces panel space; less cost

Touch-safe terminals

- Increases safety for installer/user

One- and three-phase power

- Can be used in a variety of applications

Open heater/shorted output alarm

- Notifies you in case of an open heater or shorted output

No mercury

- Assures environmental safety

Faster switching with solid state

- Saves energy and extends heater life

UL® 508 listed, C-UL® and CE with filter

- Meets applications requiring agency approval

System solution component

- Provides single source thermal loop

Back-to-back SCR design

- Ensures a rugged design



ISO 9001



Registered Company
Winona, Minnesota USA



WIN-DMC-0309

Specifications

Operator Interface

- Command signal input and indication light
- Alarm output and indication light
- Current limit indication LED

Amperage Rating

- See output rating curves on page 3
- Max. surge current for 16.6ms, 1,350A peak
- Max. I²t for fusing is 9100A²s
- Latching current: 200mA min.
- Holding current: 100mA min.
- Fan current: 0.14A for 24V~(dc); 0.12A for 120V~(ac); 0.06A for 240V~(ac)
- Off-state leakage 1mA at 77°F (25°C) max.
- Power dissipation: 1 watt per amperes per leg switched
- 200KA SCCR, Type 1 and 2 approved with the recommended fusing; see user manual

Line Voltage

- 24 to 48V~(ac) units: 20.4V~(ac) min. to 53V~(ac) max.
- 100 to 240V~(ac) units: 48V~(ac) min. to 265V~(ac) max.
- 277 to 600V~(ac) units: 85V~(ac) min. to 660V~(ac) max.
- 100 to 120V~(ac), 200 to 208V~(ac), 230 to 240V~(ac), 277V~(ac), 400V~(ac), 480V~(ac), 600V~(ac), +10/-15%, 50 to 60Hz independent ±5% (Input control signal Type L, P and S)

Alarms (zero cross models only)

Shorted SCR Alarm Option

- Alarm state when the input command signal is off and a 10A or more load current is detected by the current transformer (two turns required for 5A or three turns for 2.5A)

Open Heater Alarm Option (Input Control Signal Type S only)

- Alarm state when the input command signal is on and the load current detected by the current transformer is 20% less than customer adjusted set point

Alarm output

- Energizes on alarm, non-latching
- Triac 24 to 240V~(ac), external supply with a current rating of 300mA @ 77°F (25°C), 200mA @ 122°F (50°C), 100mA @ 176°F (80°C) and a holding current of 200 µA with a latching current of 5mA typical

Agency Approvals

- CE with proper filter:
204/108/EC Electromagnetic Compatibility Directive
EN 61326-1: Industrial Immunity Class A emissions not suitable for Class B environments
Phase angle and phase angle with current limit input control signal Types (P and L) are not CE approved for conducted or radiated emissions
2006/95/EC Low Voltage Directive EN 50178 Safety Requirements Installation category III, Pollution degree 2
- UL® 50 Type 4X enclosure, Class 1, Div. 2 per ANSI/ISA 12.12.01. Thru-wall heat sink models T4A File 184390
-  UL® 508 listed and C-UL® File E73741
- Shock and vibration tested to IEC 60068-2-32
- Vibration tested to IEC 60068-2-6

Input Terminals

- Compression: will accept 0.2 to 1.5 mm² (24 to 16 AWG) wire
- Torque to 0.5 Nm (4.4 in. lb) max. with a ¼ in. (3.5 mm) blade screwdriver

Line and Load Terminals

- Compression: will accept 2 to 21 mm² (14 to 4 AWG) wire
- Torque to 2.7 Nm (24 in. lb) max. with a ¼ in. (6.4 mm) blade screwdriver, or a type 1A, #2 Pozi driver

Operating Environment

- See the output rating curve chart on page 3
- 0 to 90% RH (relative humidity), non-condensing
- Storage temperature: -40 to 185°F (-40 to +85°C)
- Insulation only tested to 3,000 meters

DIN-Rail Mount

- DIN EN 50022, 35 mm by 7.5 mm

Back Panel Mount

- Four mounting holes M3 to M4 (No. 6 to No. 8) fastener

Through-Wall Mount

- See page 4 for thru-wall panel cutout

Note: Mount cooling fins vertically

Additional Specifications for Contactors and Proportional Controllers

Control Mode, Zero-Cross

- Input control signal Type C: V~(dc) input contactor
- Input control signal Type K: V~(ac) input contactor
- To increase service life on contactor input models the cycle time should be less than three seconds
- Input control signal Type F: 4 to 20mA~(dc) proportional variable time base control

Input Command Signal

- AC contactor
24V~(ac) ±10%, 120V~(ac) +10/-25%, 240V~(ac) +10/-25% @ 25mA max. per controlled leg
- DC contactor
4.5 to 32V~(dc): max. current @ 4.5V~(dc) is 6mA per leg. Add 2mA per LED used to the total current
- Loop powered linear current
4 to 20mA~(dc): loop-powered, input Type F0 option only, no more than three inputs connected in series. See page 5 for detail operation.

For Sales or Service:

Thermal Devices, Inc.
Mount Airy, Maryland USA
www.thermaldevices.com
sales@thermaldevices.com
Ph: 800-282-9100
Fx: 800-457-1634

Additional Specifications for Phase Angle, Phase Angle Current Limit and Single Cycle VTB

Operation

- Burst firing (zero-cross) control, single-cycle variable time base, Type S single phase and 3-phase. Unit is not on for more than one full cycle under 50% power and not off for more than one full cycle above 50% power
- Phase angle control, single-phase only

Input Command Signal

- 0 to 20mA, 4 to 20mA, 0 to 5V=(dc), 1 to 5V=(dc) and 0 to 10V=(dc)
- Input impedance 250Ω for 4mA to 20mA, 5kΩ for linear voltage input

Output Voltage

- 100 to 120V~(ac), 200 to 208V~(ac), 230 to 240V~(ac), 277V~(ac), 400V~(ac), 480V~(ac) and 600V~(ac), ±10%

Linearity (Input Control Signal Type S)

- ±5% input to output power over 0 to 100% of span between calibration points

Linearity (Phase Angle Input Control Type P and L)

- ±5% input to output power, as referenced to a sinusoidal power curve, between calibration points

Resolution

- Better than 0.1% of input span with respect to output change

Soft Start

(Phase Angle Input Control Signal Type P and L)

Typically:

- 5 seconds soft start on power up
- Soft start on thermostat overtemperature
- Soft start on ½ cycle drop out detection
- 1 second soft start on set point change

Options

- Manual Control Kit (1kΩ potentiometer) 08-5362
- Alarm option is **not** available on phase angle Input Control Signal Type P or L

Specifications are subject to change without notice.

For Sales or Service:
Thermal Devices, Inc.
Mount Airy, Maryland USA
www.thermaldevices.com
sales@thermaldevices.com
Ph: 800-282-9100
Fx: 800-457-1634

Output Rating Curves

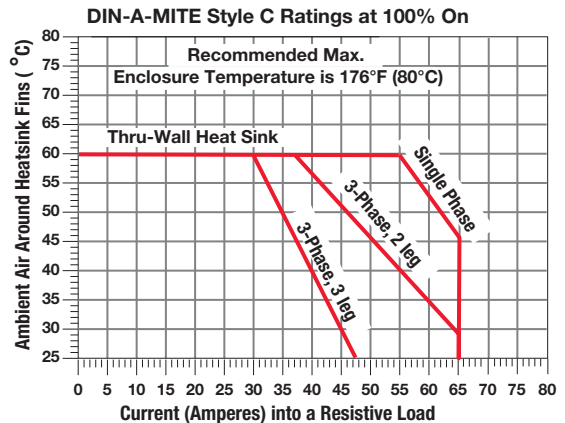
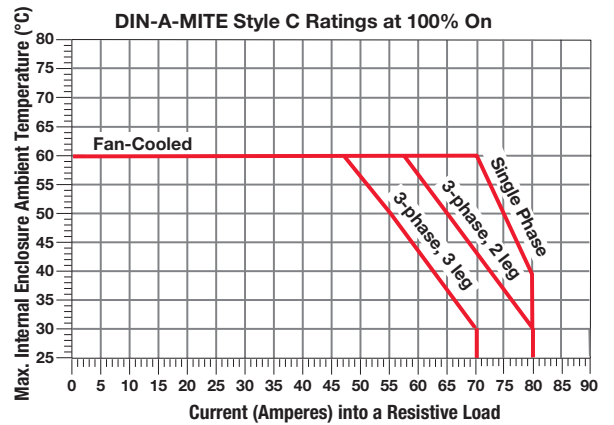
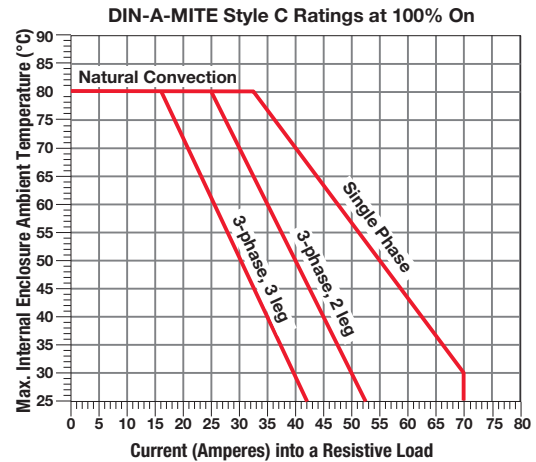

Style C Dimensions Without Cooling Fan

Front

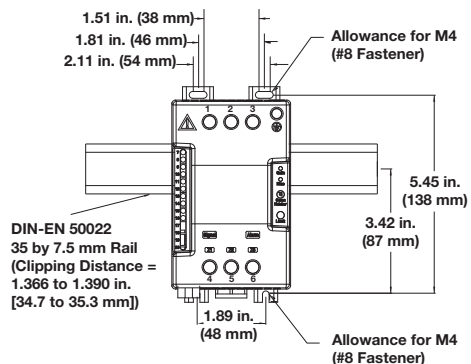

Side

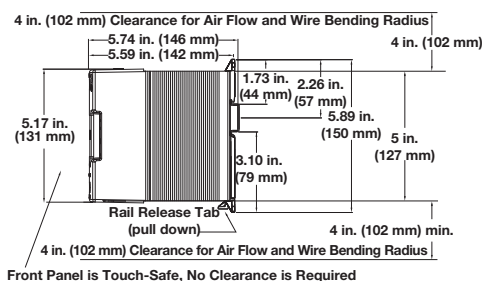

Top

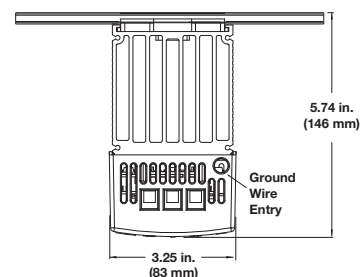

With Cooling Fan

Side

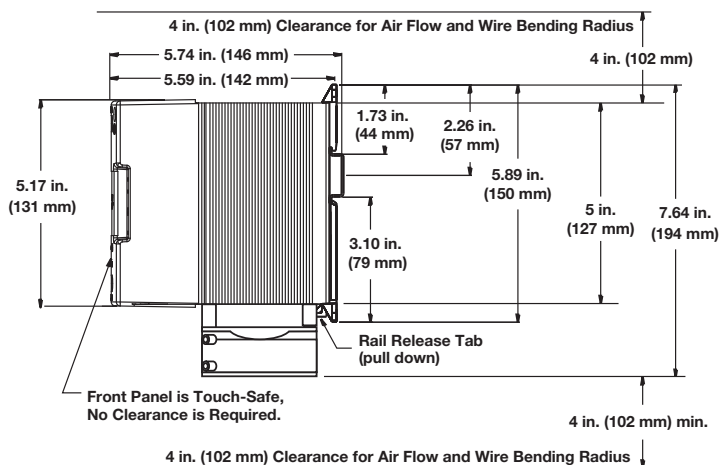

Thru-Wall Style C^①

Front

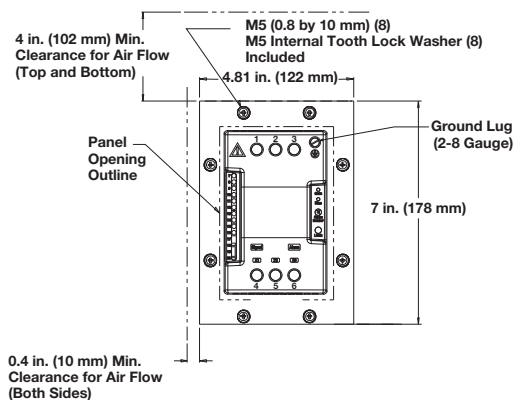

Top

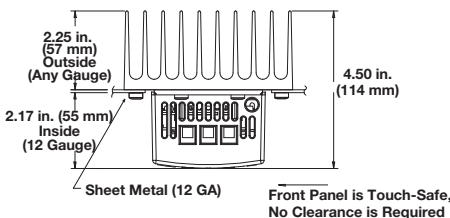

Panel Cutout

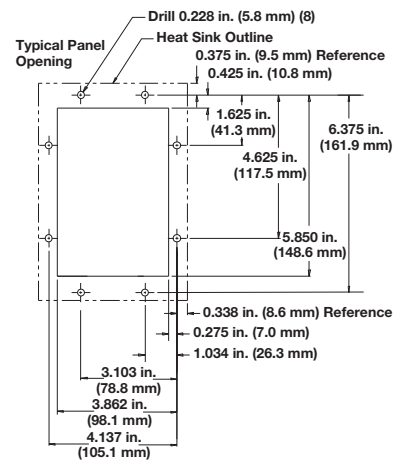

^① With the potential for high thru-wall heat sink temperatures, application may require a touch-safe shield.

For Sales or Service:

Thermal Devices, Inc.
Mount Airy, Maryland USA
www.thermaldevices.com
sales@thermaldevices.com
Ph: 800-282-9100
Fx: 800-457-1634

Extended Heater And Power Controller Life With Variable Time Base

With variable time base control, the power controller automatically adjusts the time base and output power with respect to process input. Accelerated life testing verified that variable time base control significantly reduces expansion and contraction of the heater element. This extends heater and power controller life while improving process temperature control. You save money on heaters, downtime and maintenance.

Loop Powered or Transformer Powered

Loop Powered

By using a temperature control 4-20mA process output signal as the power supply for the DIN-A-MITE input the cost of the power controller can be reduced. With zero cross (burst fired) the 4-20mA input signal simultaneously performs the tasks of providing a power supply and an input command signal. The DIN-A-MITE "F0" input control signal is a loop powered option and will work as single- or three-phase. It works only with a 4-20mA input.

Transformer Powered

Some DIN-A-MITE models require that an on-board power supply be used to power the internal electronics. Phase angle options require that we detect the zero cross of the ac sine wave and thus a transformer is required also. The DIN-A-MITE input control signal types "L", "P" and "S" are transformer powered and can be controlled manually (open loop) with a potentiometer input or in the auto mode (close loop) with a temperature control using any of the 4-20mA, linear voltage (0-5, 1-5 and 0-10V=(dc)) input types.

Loop Powered 4-20mA Variable Time Base

Models: DC__-[02, 24, 60] [F0]-_____

20% Power Output



3~ cycles on, 12~ cycles off

50% Power Output

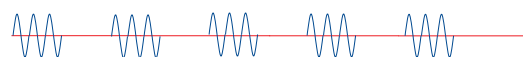

3~ cycles on, 3~ cycles off

80% Power Output



12~ cycles on, 3~ cycles off

Thermal Devices, Inc.
Mount Airy, Maryland USA
www.thermaldevices.com
sales@thermaldevices.com
Ph: 800-282-9100
Fx: 800-457-1634

Phase Angle

Models: DC1_ _ _ [L, P] 0 - 0_ _ _

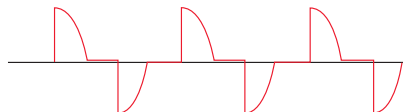

Phase angle (input control type "P") phase control is infinitely variable inside the sine wave. This provides a variable voltage and/or current output. This option includes soft start and line voltage compensation. This is transformer powered and therefore will work with a linear voltage, current input or a potentiometer input. This is single-phase only.

Single Cycle Variable Time Base

Models: DC_ _ _ S_ _ _ _ _

25% Power Output

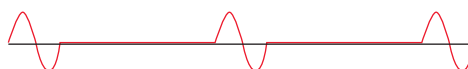

1~ line cycle on, 3 ~ cycles off

50% Power Output

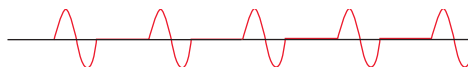

1~ line cycle on, 1 ~ cycle off

With single-cycle variable time base (VTBS) control, at 50% power, power is on one cycle and off one cycle. At 25%, it is on for one cycle and off for three. Under 50%, the unit is not on for more than one consecutive cycle. Over 50%, the unit is not off for more than one consecutive cycle. This model will work with a linear voltage input, a 4 to 20mA input or a potentiometer input.

Recommended Semiconductor Fuse for Applications Through 600V~(ac)

Fuse Rating	Wattlow	Fuse Part Number	
		Cooper Bussman®	Ferraz Shawmut
40A	17-8040	FWP-40A14F	A093909
50A	17-8050	FWP-50A14F	B093910
63A	17-8063	FWP-63A22F	T094823
80A	17-8080	FWP-80A22F	A094829
100A	17-8100	FWP-100A22F	Y094827

Fuse Rating	Fuse Holder Part Number	
	Wattlow	Ferraz Shawmut
40A	17-5114	US1411
50A	17-5114	US1411
63A	17-5122	US2211
80A	17-5122	US2211
100A	17-5122	US2211

Cooper Bussman® is a registered trademark of Cooper Bussman, Inc.

Ordering Information

To order, complete the code number on the right with the information below:

Style C = Solid-State Power Controller

D C - - - - -

Phase _____

- 1 = 1-phase, 1 controlled leg
- 2 = 3-phase, 2 controlled legs
- 3 = 3-phase, 3 controlled legs, (use with four wire wye)
- 8 = 2 independent zones (Input Type C, K)
- 9 = 3 independent zones (Input Type C, K)

Cooling and Current Rating Per Leg* (see chart below) _____

- 0 = Natural convection standard DIN-rail or panel heat sink
- 1 = Fan cooled 120V~(ac) standard DIN-rail or panel heat sink
- 2 = Fan cooled 240V~(ac) standard DIN-rail or panel heat sink.
- 3 = Fan cooled 24V~(dc) standard DIN-rail or panel heat sink
- T = Natural convection through wall or cabinet heat sink (NEMA 4X)

Line and Load Voltage _____

- 02 = 24 to 48V~(ac) (control C, F, K)
- 12 = 100 to 120V~(ac) (control L, P, S)
- 20 = 200 to 208V~(ac) (control L, P, S)
- 24 = 100 to 240V~(ac) (control C, F, K): 230 to 240V~(ac) (control L, P, S)
- 27 = 277V~(ac) (control L, P, S)
- 40 = 400V~(ac) (control L, P, S)
- 48 = 480V~(ac) (control L, P, S)
- 60 = 277 to 600V~(ac) (control C, F, K): 600V~(ac) (control L, P, S)

Input Control Signal _____

- C0 = 4.5 to 32V~(dc) contactor
- F0 = 4 to 20mA~(dc) proportional
- K1 = 22 to 26V~(ac) contactor
- K2 = 100 to 120V~(ac) contactor
- K3 = 200 to 240V~(ac) contactor
- L (0 to 5) = Phase angle with current limiting^① (single-phase only)
- P (0 to 5) = Phase angle^① (single-phase only)
- S (0 to 5) = Single cycle variable time base
 - 0 = 4 to 20mA
 - 1 = 12 to 20mA (for input control signal option S only)
 - 2 = 0 to 20mA
 - 3 = 0 to 5V~(dc) proportional
 - 4 = 1 to 5V~(dc) proportional
 - 5 = 0 to 10V~(dc) proportional

Alarm _____

- 0 = No alarm
- S = Shorted SCR alarm (zero cross models only)
- H = Open-heater and shorted-SCR alarm (for input control signal option S)

Language _____

- 0 = English
- 1 = German
- 2 = Spanish
- 3 = French

Custom Part Numbers _____

- 00 = Standard part
- 1X = 1-second soft start (control option P, L)
- XX = Any letter or number, custom options, labeling, etc.

^① Not CE Approved for conducted or radiated emissions.

*DIN-A-MITE C Current Rating Table

Phase	Cooling	Current at 50°C (122°F)
1	0	55A
1	T	60A
1	(1, 2, 3)	75A
2, 8	0	40A
2, 8	T	46A
2, 8	(1, 2, 3)	65A
3, 9	0	30A
3, 9	T	35A
3, 9	(1, 2, 3)	55A

Your Authorized Watlow Distributor Is:

Thermal Devices, Inc.
 Mount Airy, Maryland USA
www.thermaldevices.com
sales@thermaldevices.com
 Ph: 800-282-9100
 Fx: 800-457-1634